

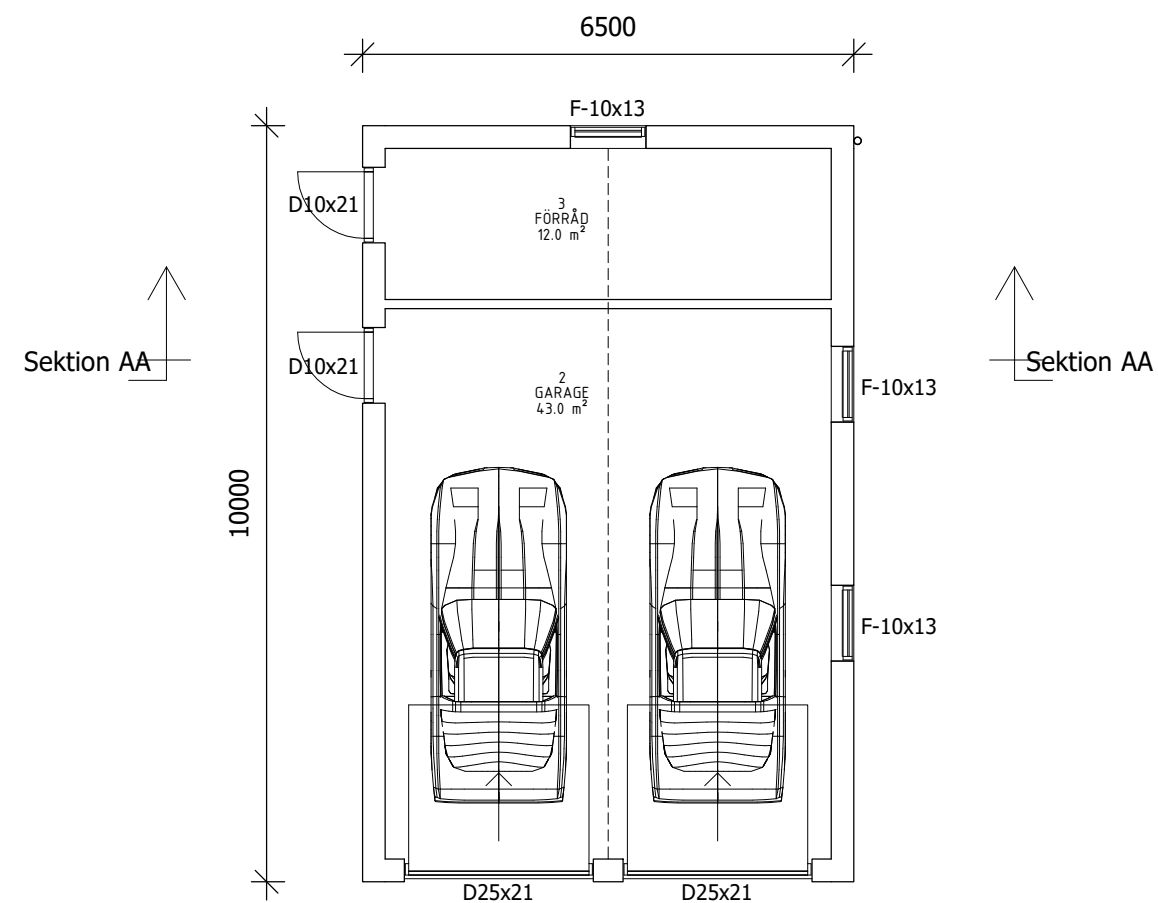

BET	ÄNDRINGEN AVSER	DATUM	SIGN
	BYGGLOVSHANDLING - NYBYGGNATION AV GARAGE		
	SEKTIONS-RITNING FASTIGHETS BET.		
	DEL AV MÅLHAMRA 1:8, NORRTÄLJ		
KTTK ARKITEKTUR & BYGG AB WWW.KTTK.SE INFO@KTTK.SE	UPPDRAGS.NR 1094-01	SKALA A3 1 : 100	
RITAD AV Tommy K	DATUM 2020-07-30	RITNINGSNUMMER A-40.0-03	SIGN <i>Tommy K</i>



BET	ÄNDRINGEN AVSER	DATUM	SIGN
	BYGGLOVSHANDLING - NYBYGGNATION AV GARAGE		
	PLANRITNING FASTIGHETS BET.		
KTTK ARKITEKTUR & BYGG AB WWW.KTTK.SE INFO@KTTK.SE		UPPDRAGS.NR 1094-01	SKALA A3 1 : 100
RITAD AV Tommy K	DATUM 2020-07-30	RITNINGNUMMER A-40.1-01	SIGN 

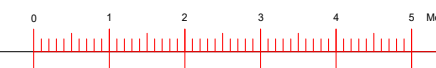

1
1 : 100 Fasad mot Norr

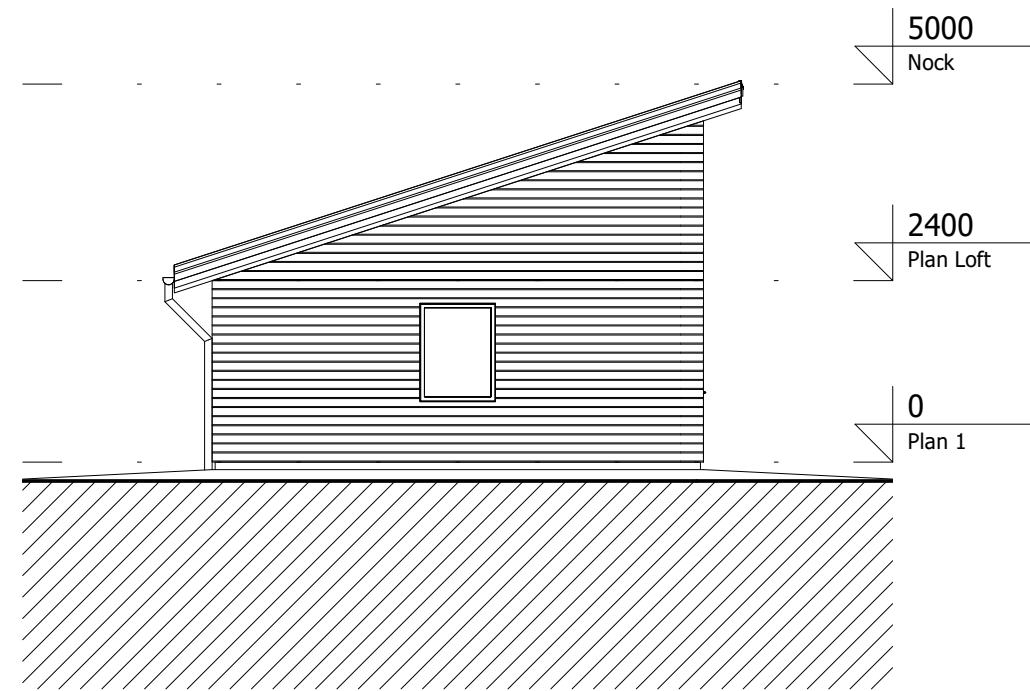



MATERIAL & FÖRUTSÄTTNINGAR:

FASAD	LIGGANDE PANEL, VIT.
SNICKERIER	TRÄ, VITA
FÖNSTER	TRÄ, VITA
DÖRRAR	TRÄ, VITA
TAK	TEGELPANNOR, GRÅ
SOCKEL	PUTS, GRÅ

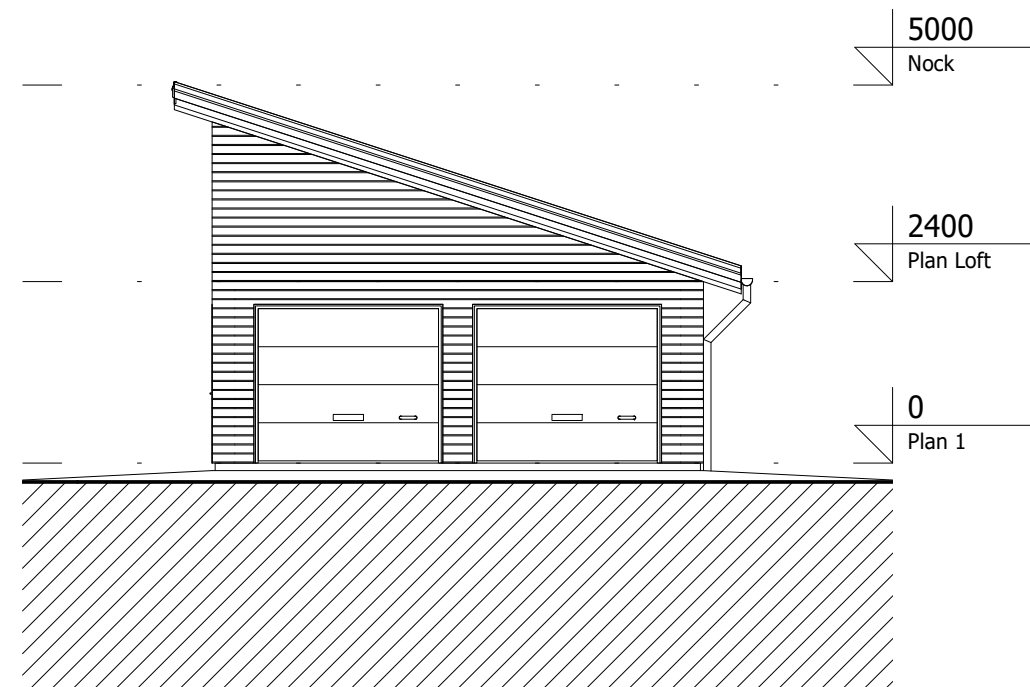
2
1 : 100 Fasad mot Söder



BET	ÄNDRINGEN AVSER	DATUM	SIGN
		BYGGLOVSHANDLING - NYBYGGNATION AV GARAGE	
		FASADRITNINGAR FASTIGHETS BET.	
KTTK ARKITEKTUR & BYGG AB WWW.KTTK.SE INFO@KTTK.SE		UPPDRAGS.NR 1094-01	SKALA A3 1 : 100
RITAD AV Tommy K	DATUM 2020-07-30	RITNINGNUMMER A-40.3-01	SIGN 

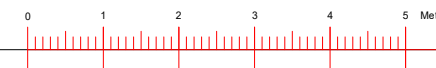

1
1 : 100 Fasad mot Väster

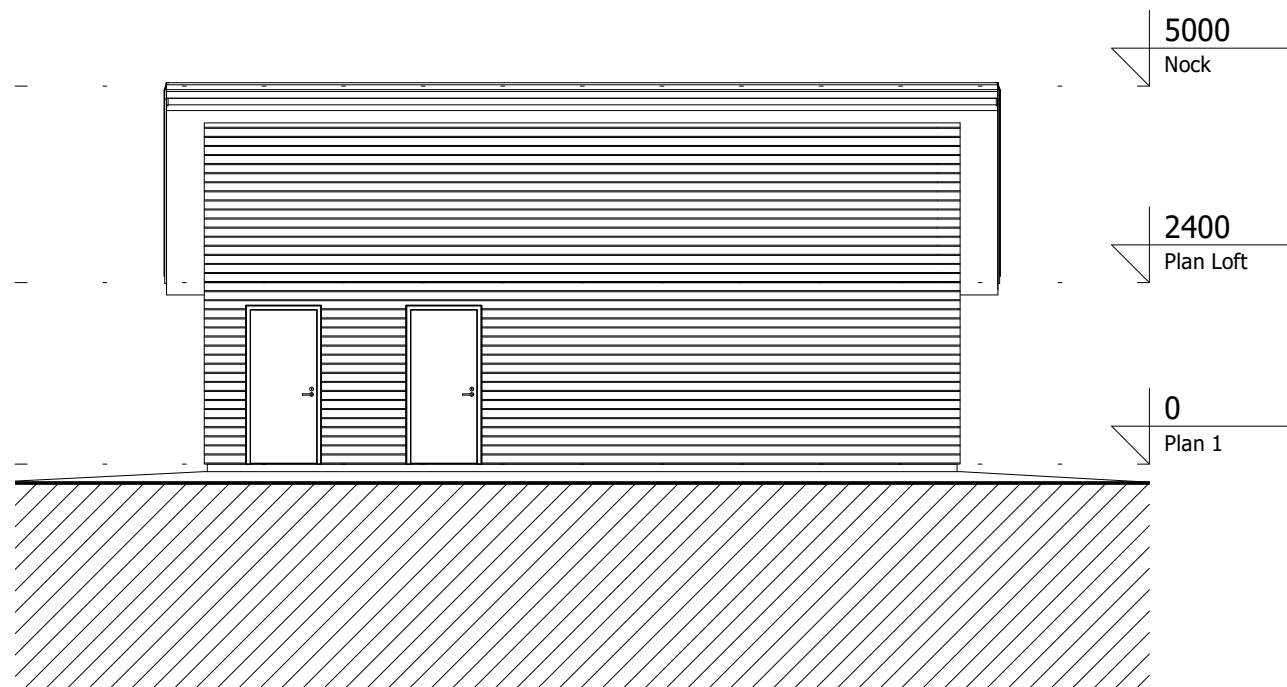

MATERIAL & FÖRUTSÄTTNINGAR:

FASAD	LIGGANDE PANEL, VIT.
SNICKERIER	TRÄ, VITA
FÖNSTER	TRÄ, VITA
DÖRRAR	TRÄ, VITA
TAK	TEGELPANNOR, GRÅ
SOCKEL	PUTS, GRÅ

2
1 : 100 Fasad mot Öster

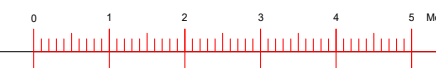
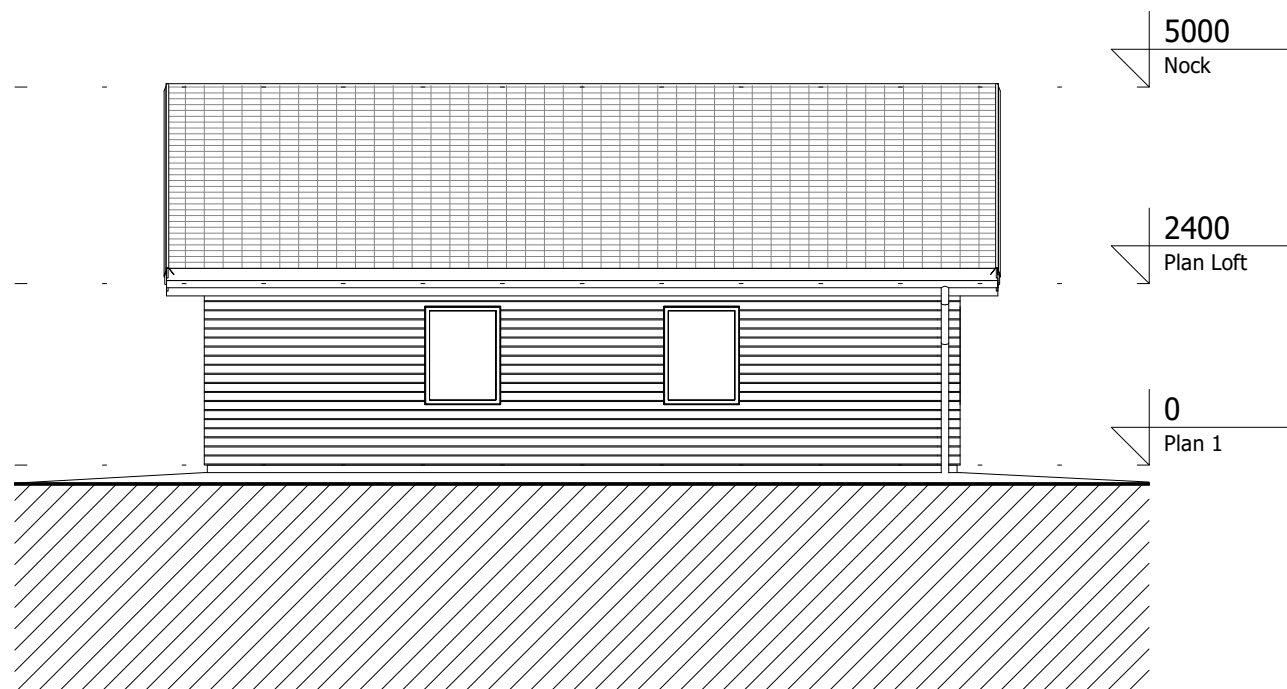

BET	ÄNDRINGEN AVSER	DATUM	SIGN
		BYGGLOVSHANDLING - NYBYGGNATION AV GARAGE	
		FASADRITNINGAR FASTIGHETS BET.	
KTTK ARKITEKTUR & BYGG AB WWW.KTTK.SE INFO@KTTK.SE		DEL AV MÅLHAMRA 1:8, NORRTÄLJE	
		UPPDRAGS.NR 1094-01	SKALA A3 1 : 100
RITAD AV Tommy K	DATUM 2020-07-30	RITNINGNUMMER A-40.3-02	SIGN <i>Tommy K</i>